





Prese ad Innesto Rapido - Quick Couplings - Schnellverschluss Kupplungen - Coupleurs Automatiques - Enchufes Rápidos - Conexões de Engate Rápido

<p>SERIE UNI ISO 6150 A-6</p>  <p>Serie 100 Pag. 16.7 - 16.10</p>	<p>SERIE MIGNON</p>  <p>Serie 110 Pag. 16.11 - 16.16</p>	<p>SERIE UNI ISO 6150 B-12</p>  <p>Serie 120 Pag. 16.17 - 16.22</p>	<p>ITALIAN PROFILE</p>  <p>Serie 120 Pag. 16.23 - 16.28</p>
<p>SERIE UNI ISO 6150 B-15</p>  <p>Serie 130 Pag. 16.29 - 16.33</p>	<p>SERIE UNI ISO 6150 C-10</p>  <p>Serie 140 Pag. 16.34 - 16.39</p>	<p>EUROPEAN PROFILE</p>  <p>Serie 160 Pag. 16.40 - 16.45</p>	<p>SWISS PROFILE</p>  <p>Serie 170 Pag. 16.46 - 16.50</p>
<p>MIGNON PROFILE</p>  <p>Serie 180 Pag. 16.51 - 16.54</p>	<p>MULTISOCKET</p>  <p>Serie 190 - 63190 Pag. 16.55 - 16.61</p>	<p>JAPANESE PROFILE</p>  <p>Serie 400 Pag. 16.62 - 16.64</p>	<p>MINI DN 2,7</p>  <p>Serie 700 Pag. 16.65 - 16.67</p>
<p>SERIE UNI ISO 6150 B-17</p>  <p>Serie 710 Pag. 16.68 - 16.70</p>	<p>B-SOCKET EUROPEAN</p>  <p>Serie 720 Pag. 16.71 - 16.74</p>	<p>EUROPEAN PROFILE</p>  <p>Serie 730 Pag. 16.75 - 16.80</p>	<p>EUROPEAN PROFILE</p>  <p>Serie 740 Pag. 16.81 - 16.83</p>

Prese di Sicurezza ad Innesto Rapido - Safety Quick Couplings - Kupplungen Sicherheit - Coupleurs de Sécurité - Enchufes de Seguridad - Conexões de Segurança

<p>SERIE UNI ISO 6150 B-12</p>  <p>Serie 620 Pag. 16.85 - 16.88</p>	<p>ITALIAN PROFILE</p>  <p>Serie 650 Pag. 16.89 - 16.90</p>	<p>EUROPEAN PROFILE</p>  <p>Serie 660 Pag. 16.91 - 16.92</p>	<p>SWISS PROFILE</p>  <p>Serie 670 Pag. 16.93 - 16.94</p>
<p>SERIE UNI ISO 6150 B-12</p>  <p>Serie OB120 Pag. 16.97 - 16.99</p>	<p>SERIE UNI ISO 6150 C-10</p>  <p>Serie OB140 Pag. 16.100 - 16.102</p>		

Giunti ad Innesto Rapido per Raffreddamento Stampi - Quick Couplings for Molding Cooling - Schnellkupplungen für Spritzgussanwendungen - Coupleurs pour Moulages D'injection - Enchufes Rápidos para Refrigeración de Moldes - Conexões de Engate Rápido para Resfriamento de Moldes

<p>FRENCH PROFILE DN 8 - DN 12</p>  <p>Serie 410 - 420 - 510 - 520 Pag. 16.104 - 16.110</p>	<p>INTERNATIONAL PROFILE DN 6 - DN 9</p>  <p>Serie 430 - 440 - 530 - 540 Pag. 16.112 - 16.119</p>	<p>EUROPEAN PROFILE DN 6 - DN 9</p>  <p>Serie 460 - 470 - 560 - 570 Pag. 16.120 - 16.127</p>	<p>6049 Pag. 16.128</p>  <p>New</p>
--	--	--	--

Pistole di Soffiaggio - Blow Guns - Blaspistolen - Soufflettes - Pistolas Sopladoras - Pistola de Ar

<p>Series 360 Pag. 16.130 - 16.131</p>  <p>New</p>	<p>Series 300 Pag. 16.133 - 16.135</p> 	<p>Spare Parts Pag. 16.136</p> 	<p>Series 340 Pag. 16.137 - 16.138</p> 
---	---	--	---

Aignep si riserva il diritto di variare modelli e ingombri senza preavviso - Aignep reserves the right to vary models and dimensions without notice - Aignep behält sich das Recht vor, Daten ohne Ankündigung zu ändern
 Aignep se reserva el derecho de modificar modelos y dimensiones sin previo aviso - Aignep se réserve le droit de modifier les données sans préavis - Aignep reserva-se o direito de alterar os modelos e dimensões sem prévio aviso

GIUNTI AD INNESTO RAPIDO E PISTOLE AD ARIA

AUTOMATIC QUICK COUPLINGS AND BLOW GUNS

SCHNELLVERSCHLUSS-KUPPLUNGEN UND BLASPISTOLEN

COUPLEURS AUTOMATIQUES ET SOUFFLETTES

ENCHUFES RÁPIDOS Y PISTOLAS DE AIRE

CONEXÕES DE ENGATE RÁPIDO E PISTOLAS DE AR



Serie Quick Couplings

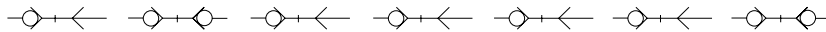

PLUG PROFILE 1:1	STANDARD	SINGLE SHUT OFF	DOUBLE SHUT OFF	STANDARD	MULTI	SAFETY	INOX	DOUBLE SHUT OFF	
	DN 5 MIGNON	210 Pag. 15.11	280 Pag. 15.51	110 Pag. 15.11				180 Pag. 15.51	
	DN 2.5 UNI-ISO 6150-A6	200 Pag. 15.7		100 Pag. 15.7					
	DN 5.5 UNI-ISO 6150-B12 INDUSTRIAL 1/4	220 Pag. 15.17		120 Pag. 15.17	190 Pag. 15.55	620 Pag. 15.87 OB120 Pag. 15.97			
	DN 9 UNI-ISO 6150-B15 INDUSTRIAL 3/8	230 Pag. 15.29		130 Pag. 15.29	720 Pag. 15.71				
	DN 12 UNI-ISO 6150-B17 INDUSTRIAL 1/2	810 Pag. 15.68		710 Pag. 15.68					
	DN 5.5 UNI-ISO 6150-C10	240 Pag. 15.34		140 Pag. 15.34		OB140 Pag. 15.100			
	DN 7.5 - 7.8 EUROPEAN	260 Pag. 15.40	63260 Pag. 15.59	840 Pag. 15.81	160 Pag. 15.40 730 Pag. 15.75	190 Pag. 15.55	660 Pag. 15.91	63190 Pag. 15.59	740 Pag. 15.81
	DN 10 EUROPEAN DN 10	820 Pag. 15.71		720 Pag. 15.71					
	DN 5.5 SWISS	270 Pag. 15.46		170 Pag. 15.46	190 Pag. 15.55	670 Pag. 15.93			
	DN 7.5 JAPANESE	500 Pag. 15.62		400 Pag. 15.62					
	DN 5 ITALIAN	250 Pag. 15.23		120 Pag. 15.23	190 Pag. 15.55	650 Pag. 15.89			
	DN 2.7 MINI	800 Pag. 15.65		700 Pag. 15.65					
	DN 8 FRENCH	510 Pag. 15.106		410 Pag. 15.106					
	DN 12 FRENCH	520 Pag. 15.109		420 Pag. 15.109					
	DN 6 INTERNATIONAL	530 Pag. 15.114		430 Pag. 15.114					
	DN 9 INTERNATIONAL	540 Pag. 15.117		440 Pag. 15.117					
	DN 6 EUROPEAN	560 Pag. 15.122		460 Pag. 15.122					
	DN 9 EUROPEAN	570 Pag. 15.125		470 Pag. 15.125					

AIR

WATER / OIL

RECTUS/LEGRIS PARKER 21/90	CAMOZZI 5050 - 5150	CEJN 220		FESTO KD - KS 3		
RECTUS/PARKER 21/90	CAMOZZI 5050 - 5150	CEJN 200				
				FESTO KD - KS 2		
RECTUS/LEGRIS 23/24 PARKER 20/30 - 1/4 TEMA 1400	HANSEN 3000	CEJN 310	INDUSTRIAL 1/4	GROMELLE 600	US - MIL SPEC C-4109	
RECTUS/LEGRIS 30 PARKER 30 - 3/8	HANSEN 4000	CEJN 430	INDUSTRIAL 3/8	GROMELLE 900	US - MIL SPEC C-4109	
RECTUS 37	HANSEN 5000	CEJN 550		GROMELLE 1300	US - MIL SPEC C-4109	
RECTUS/LEGRIS 18			AIR			
RECTUS/LEGRIS 25/26/1600/1625 TEMA 1600	CAMOZZI 5080 - 5180	CEJN 320			FESTO KD - KS 6 KD - KS 4	
RECTUS/LEGRIS 27		CEJN 410				
RECTUS/LEGRIS 14/22 PARKER 50	HANSEN 210	CEJN 300		ARO 210		
RECTUS/LEGRIS 13	SMC KK130	CEJN 315	NITTO KOHKI 200			
RECTUS/LEGRIS PARKER 20/91				FESTO KD - KS 2		
RECTUS 608			WATER / OIL			
RECTUS 612						
RECTUS 86	DME 1/4					
RECTUS 87	DME 3/8					
RECTUS 10	HASCO Z80/811HT/9 [Øe 9]	CEJN 220 - 221 - 225				
RECTUS 11	HASCO Z80/811HT/13 [Øe 13.5]					

La gamma dei giunti ad innesto rapidi Aignep permette una risposta adeguata ai molteplici bisogni dei nostri clienti. Le differenti applicazioni, le prestazioni e l'affidabilità, sono i vantaggi dati dall'insieme di questa importantissima gamma.

A semplice o doppia intercettazione in ottone nichelato, in acciaio inox, conformi alle principali norme di riferimento possono essere utilizzati per veicolare molteplici fluidi.

A completamento pistole di soffiaggio.

Principali vantaggi

- Passaggi da DN 2,5 a 12 mm
- Profili normalizzati
- Gamme Multipresa
- Montaggio con una sola mano
- Leggerezza ed ingombro ridotto
- Versioni di sicurezza
- Raffreddamento stampi normalizzati
- Silicon Free

Applicazioni

- Impianti Aria Compressa e Strumenti
- Automazione Pneumatica e Fluidica
- Food & Beverage
- Life & Sciences
- Raffreddamento stampi
- Gas inerti, versioni per vuoto

Aignep range of quick couplings is able to satisfy multiple needs of our customers.

Wide variety of models: single & double shut-off, multisocket, safety.

The most popular profiles and nominal diameters available in nickel-plated brass and stainless steel.

For compressed air and for moulding injection cooling system.

To complete the line a wide range of air blow guns.

Main advantages

- DN 2,5 - 12 mm
- Standard profiles
- Multisocket
- Single handed operation
- Light and compact
- Safety version
- Moulding couplers
- Silicon Free

Applications

- Compressed Air & Tools
- Pneumatic & Fluidtechnology
- Food & Beverage
- Life & Sciences
- Cooling System
- Inert Gases, Vacuum

Die Schnellverschlusskupplungs-Serie von Aignep antwortet auf die vielfältigen Bedürfnisse unserer Kunden. Zahlreiche verschiedene Modelle: Einzel- und Doppelabspernung, Mehrfachstecker, Sicherheitskupplungen.

Die beliebtesten Profile und Nennweiten sind aus vernickeltem Messing und Edelstahl verfügbar.

Für Druckluft und für Spritzguss-Kühlsysteme. zu formen. Zur Vervollständigung der Serie eine große Auswahl an Blaspistolen.

Hauptvorteile

- DN 2,5 - 12 mm
- Standard Profile
- Mehrfachstecker
- Einhändige Bedienung
- Leicht und kompakt
- Sicherheits Versionen
- Spritzwerkzeug-Kühlung
- Silikonfrei

Anwendungen

- Druckluft & Werkzeuge
- Pneumatik und Fluidtechnik
- Lebensmittel & Getränke
- Life Science
- Kühlsysteme
- Inertgase, Vakuum

FR

Les coupleurs rapides Aignep répondent à de nombreuses utilisations. Grande variété de modèles en version simple et double obturation, multiprise, de sécurité. Les profils et les diamètres nominaux les plus courants sont disponibles en laiton nickelé et acier inoxydable 316L.

Pour air comprimé et tous fluides industriels ainsi qu'une gamme dédiée pour le refroidissement des moules dans l'injection plastique. Une large gamme de soufflettes vient compléter notre offre.

Principaux avantages

- DN 2,5 - 12 mm
- Profils standards
- Multisocket
- Opération d'une seule main
- Léger et compact
- Version de sécurité
- Coupleurs pour moule
- Sans silicone

Applications

- Air comprimé
- Outillage pneumatique
- Agro alimentaire
- Sciences de la vie
- Système de refroidissement
- Gaz neutres, vide

ES

La gama de enchufes rápidos Aignep permite una respuesta adecuada a las múltiples necesidades de nuestros clientes. Las diferentes aplicaciones, las prestaciones y la fiabilidad, son las ventajas que ofrece esta importantísima gama.

A simple y doble obturación en latón níquelado, acero inox, conforme a las principales normas de referencia pueden ser utilizados para vehicular múltiples fluidos. Completan esta gama las pistolas de soplado.

Principales ventajas

- Pasos de DN 2,5 a 12 mm
- Perfiles normalizados
- Gama Multipresa
- Montaje con una sola mano
- Ligereza y reducidas dimensiones
- Versión de seguridad
- Refrigeración de moldes normalizados
- Libres de silicona

Aplicaciones

- Instalaciones de aire comprimido y herramientas
- Automatización neumática y fluidica
- Alimentos y bebidas
- Life & Science
- Refrigeración de moldes
- Gases inertes, versiones para vacío

PT

A linha de engates rápidos Aignep pode satisfazer as diferentes necessidades dos consumidores. Ampla gama: fechamento simples ou duplo, multisocket, segurança.

Os itens mais populares e diâmetros nominais estão disponíveis em latão níquelado ou aço inox.

A linha é adequada para ar comprimido e resfriamento de moldagem.

Completam a linha as pistolas de ar.

Principais Vantagens

- DN 2,5 - 12 mm
- Perfil-padrão
- Multisocket
- Instalação fácil - com uma só mão
- Leve e compacta
- Engate de Segurança
- Engates Resfriamento
- Livre de silicone

Aplicação

- Ar Comprimido & Ferramentas
- Pneumática & Tecnologia de Fluidos
- Alimentos e bebidas
- Life & Sciences
- Sistemas de Resfriamento
- Gases Inertes, Vácuo

SERIE 720 B-SOCKET

EUROPEAN DN 10 / UNI ISO 6150 B-15

Un'unica presa per 2 tipi di innesti
IT

È un dato di fatto che sul mercato esistono vari profili di innesti ben distinti sia nella forma che nelle dimensioni e generalmente necessitano di essere assemblati con specifiche prese che di norma non sono intercambiabili fra di loro.

Per poter ovviare a questa incompatibilità AIGNEP propone alla sua clientela una soluzione pratica ed economica, un'unica presa da utilizzare con 2 differenti tipi di profili garantendo per tutti una perfetta tenuta.

One socket for 2 different plugs
GB

It is a matter of fact that on the market are available various types of plugs well distinguished whether on the shape or on the dimensions, usually they need to be assembled with specific sockets which normally are not interchangeable.

To get round to this incompatibility AIGNEP is proud to offer to its customers a practical and cost-effective solution, a unique socket to be used with 2 different types of plugs, ensuring a perfect tightening.

1 Kupplung Für 2 Typen Von Steckern
DE

Es ist eine Tatsache, dass die auf dem Markt verfügbaren Kupplungen und Stecker mit verschiedenen, nicht kompatiblen Profilen in Form und Grösse geliefert werden, d.h. sie können nicht untereinander ausgetauscht montiert werden.

Um diese Austauschbarkeit zu ermöglichen, bietet AIGNEP seinen Kunden eine praktische und kostengünstige Lösung an, wo mit einer Kupplung 2 verschiedene Profile (Stecker) verwendet werden können und dennoch eine perfekte Abdichtung gewährleistet ist.

1 Corps Pour 2 Embouts
FR

Le marché met à disposition des utilisateurs des différents types de coupleurs qui varient selon les normes, la forme et les dimensions. Souvent il est nécessaire d'assembler plusieurs types de coupleurs qui ne sont pas interchangeables.

Pour contourner cette incompatibilité AIGNEP est fière d'offrir à ses clients une solution pratique, fiable et rentable où un corps unique pour être utilisé avec 2 embouts différents.

Un único enchufe para 2 tipos de adaptador
ES

Es un dato a remarcar que en el mercado existen varios tipos de adaptadores distintos, ya sea en la forma como en las dimensiones, que generalmente necesitan de enchufes específicos no intercambiables entre ellos.

Para solucionar este problema AIGNEP, propone una solución práctica y económica de intercambiabilidad con todos los adaptadores homologados en el mercado europeo, garantizando para todos una perfecta estanqueidad.

Um único soquete p/ 2 tipos de plugs
PT

É um fato que no mercado existem vários perfis de plug bem diferentes entre si, seja no seu formato ou com relação às suas medidas e que, por isto normalmente não são intercambiáveis, necessitando de um soquete específico para cada diferente tipo de plug.

Para fugir desta incompatibilidade de tipos de modelos a AIGNEP propõe a seus clientes uma solução prática e econômica: um único soquete para ser utilizado com 2 diferentes tipos de perfis, garantindo para todos uma vedação perfeita.



CARATTERISTICHE TECNICHE
 TECHNICAL CHARACTERISTICS
 TECHNISCHE ANGABEN
 CARACTÉRISTIQUES TECHNIQUES
 CARACTERÍSTICAS TÉCNICAS
 CARACTERÍSTICAS TÉCNICAS



Norma di Riferimento
 Reference standard
 Entspricht der Norm
 Norme de référence
 Normativa de referencia
 Norma de referència

1907/2006
REACH ✓

2011/65/CE
RoHS ✓

PED
 2014/68/UE

**SILICON
 FREE**

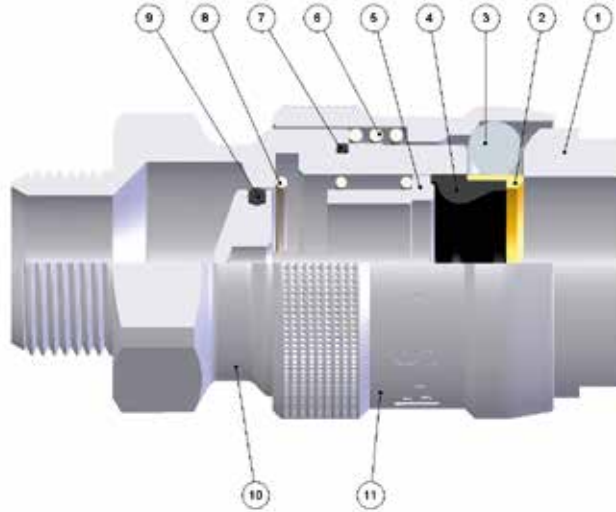

FKM A RICHIESTA
 IF REQUESTED FKM
 FKM AUF ANFRAGE
 FKM SUR DEMANDE
 FKM BAJO DEMANDA
 FKM SOB ENCOMENDA

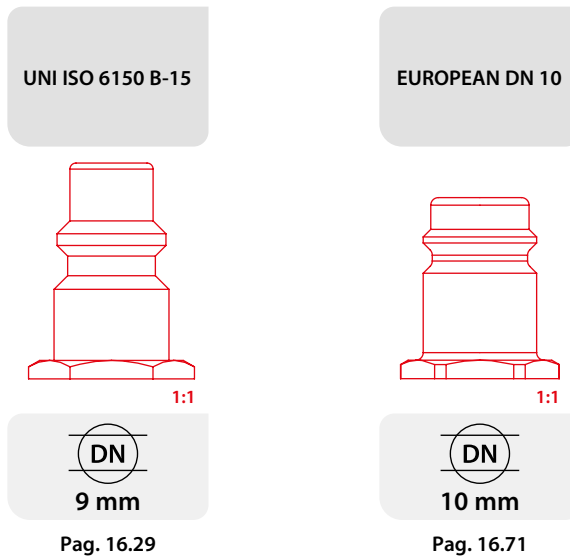

Pag. 16.29

Pag. 16.71

Materiali e Componenti	IT	Component Parts and Materials	GB	Komponenten und Materialien	DE
1 Corpo in Ottone Nichelato		1 Nickel-Plated Brass Body		1 Körper Messing Vernickelt	
2 Anello Guida Innesto in Ottone Giallo		2 Yellow Brass Guide Ring Coupling		2 Hülse Messing	
3 Sfera in Acciaio AISI 420		3 Stainless Steel AISI 420 Balls		3 Kugel Edelstahl AISI 420	
4 Guarnizione Sagomata Innesto in NBR		4 NBR Plug Molded Seals		4 Dichtung NBR	
5 Otturatore in Ottone Nichelato		5 Nickel-Plated Brass Shutter		5 Verschluss Messing Vernickelt	
6 Molla Ghiera in Acciaio AISI 302		6 Stainless Steel AISI 302 Ring Nut Spring		6 Entriegelungsfeder Edelstahl AISI 302	
7 Guarnizione O-Ring in NBR		7 NBR O-Ring Seals		7 O-Ring NBR	
8 Molla Otturatore in Acciaio AISI 302		8 Stainless Steel AISI 302 Shutter Spring		8 Verschlussfeder Edelstahl AISI 302	
9 Guarnizione O-Ring in NBR		9 NBR O-Ring Seals		9 O-Ring NBR	
10 Attacco Terminale in Ottone Nichelato		10 Nickel-Plated Brass Coupling Back Part		10 Einschraubkörper Messing Vernickelt	
11 Ghiera in Ottone Nichelato		11 Nickel-Plated Brass Sleeve		11 Entriegelungshülse Messing Vernickelt	

Matériaux et Composants	FR	Materiales y Componentes	ES	Materialis e Componentes	PT
1 Corps: Laiton Nickelé		1 Cuerpo en latón niquelado		1 Corpo em latão niquelado	
2 Bague: Laiton		2 Anillo en latón		2 Anel em latão	
3 Bille: Acier Inoxydable AISI 420		3 Esfera en acero AISI 420		3 Esfera em aço AISI 420	
4 Joint En NBR		4 Junta en NBR		4 Vedação em NBR	
5 Clapet En Laiton Nickelé		5 Obturador en latón niquelado		5 Obturador em latão niquelado	
6 Ressort De Bague: Acier Inoxydable AISI 302		6 Muelle tuerca en acero AISI 302		6 Mola de porca em aço AISI 302	
7 Joint Torique En NBR		7 Junta tórica en NBR		7 Vedação O-Ring em NBR	
8 Ressort De Clapet: Acier Inoxydable AISI 302		8 Muelle obturador en acero AISI 302		8 Mola do obturador em aço AISI 302	
9 Joint Torique En NBR		9 Junta tórica en NBR		9 Vedação O-Ring em NBR	
10 Corps: Laiton Nickelé		10 Conexión terminal en latón niquelado		10 Conexão terminal em latão niquelado	
11 Bague: Laiton Nickelé		11 Tuerca en latón niquelado		11 Porca em latão niquelado	



Pressione d'esercizio

Working Pressures

Betriebsdruck

Pression de service

Presión de Ejercicio

Pressão de Trabalho

0 bar

16 bar



Max pressione statica (no pulsazioni)

Maximum static pressure (no pulsations)

Maximaler statischer Betriebsdruck (ohne pulsations)

Pression statique maximale (sans pulsation)

Presión estática máxima (sin pulsaciones)

Pressão estática máxima (sem pulsações)

35 bar



Temperature

Temperatures

Temperatur

Températures

Temperaturas

Temperaturas

- 20 °C

+ 80 °C

Con O-ring in FKM

With FKM O-ring

Mit O-ring in FKM

Avec joints en FKM

Con junta tórica en FKM

Com O-ring em FKM

- 10 °C

+ 200 °C



Fluidi compatibili

Aria compressa

Fluids

Compressed air

Geeignete Medien

Druckluft

Fluides compatibles

Air comprimé

Fluidos compatibles

Aire comprimido

Fluidos compatíveis

Ar comprimido

Per altri fluidi, consultare l'ufficio tecnico Aignep.

For other fluids, consult the technical department Aignep.

Für andere Flüssigkeiten, kontaktieren Sie uns.

Pour d'autres fluides, veuillez nous consulter.

Para otros fluidos póngase en contacto con el departamento técnico Aignep.

Para outros fluidos consulte o departamento técnico da Aignep.



Portata

NI/min

Flow Rate

Durchflusswerte

Débit

Caudal de Flujo

Vazão

DN	6 bar Δ 1	6 bar Δ 0.5	6 bar *
9	3150	2500	3650
10	3300	2600	3800

* Scarico libero - Exhaust Free - Kostenlose Auspuff - Échappement libre - Escape Libre - Descarga livre.



Filettatura

IT

Threads

GB

Gewindearten

DE

Gas cilindrica conforme ISO 228 Classe A.

Parallel gas in conformity with ISO 228 Class A.

Zylindrisches Gewinde nach Norm ISO 228 Classe A.

Filetages

FR

Roscas

ES

Roscas

PT

Filetage cylindrique conforme: ISO 228 Class A.

Gas cilíndrica conforme ISO 228 Clase A.

Gas paralela conforme ISO 228 Classe A.

721

PRESA MASCHIO

MALE SOCKET
 VERSCHLUSS-KUPPLUNG MIT AUSSENGEWINDE
 COUPLEUR MÂLE
 ENCHUFE MACHO
 SOQUETE COM ROSCA MACHO

Code	A	B	C	D	CH	Pack.
00721 00 002	3/8	9	54.5	28	24	10
00721 00 003	1/2	10	55.5	28	24	10

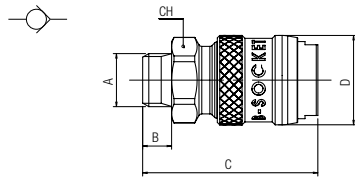

722

PRESA FEMMINA

FEMALE SOCKET
 VERSCHLUSS-KUPPLUNG MIT INNENGEWINDE
 COUPLEUR FEMELLE
 ENCHUFE HEMBRA
 SOQUETE COM ROSCA FÊMEA

Code	A	B	C	D	CH	Pack.
00722 00 002	3/8	11.5	55	28	24	10
00722 00 003	1/2	12	56.5	28	24	10

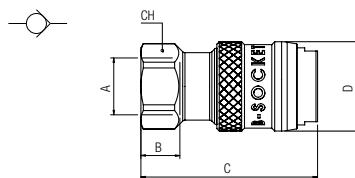

821

INNESTO MASCHIO

MALE PLUG
 STECKER MIT AUSSENGEWINDE
 EMBOUT MÂLE
 ADAPTADOR MACHO
 PLUG COM ROSCA MACHO

Code	A	B	C	CH	Pack.
00821 00 01 04 NB	3/8	9	35.5	19	10
00821 00 01 05 NB	1/2	10	37	24	10

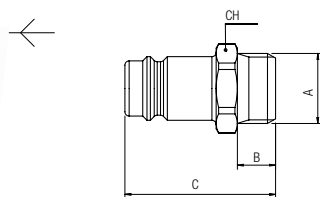

822

INNESTO FEMMINA

FEMALE PLUG
 STECKER MIT INNENGEWINDE
 EMBOUT FEMELLE
 ADAPTADOR HEMBRA
 PLUG COM ROSCA FÊMEA

Code	A	B	C	CH	Pack.
00822 00 01 04 NB	3/8	11.5	34	19	10
00822 00 01 05 NB	1/2	14	37	24	10

